



50Ω TERMINATED    3 GHz    SMA    FAILSAFE    D.P.3.T.    SWITCH

OPTIONS : INDICATOR

**R F CHARACTERISTICS**

FREQUENCY RANGE : 0 - 3 GHz  
 IMPEDANCE : 50 Ohms

FREQUENCY (GHz)	0 - 3
V.S.W.R <=	1.20
INSERT. LOSS <=	0.20 dB
ISOLATION >=	80 dB
AVER. POWER (*)	240 W

**ELECTRICAL CHARACTERISTICS**

ACTUATOR : FAILSAFE  
 NOMINAL CURRENT AT 25°C (±10%) : 500 mA  
 ACTUATOR VOLTAGE (Vcc) : 12V (10 to 13V)  
 TERMINALS : solder pins (250°C max./30 sec.)  
 INDICATOR RATING : 1 W / 30 V / 100 mA

**MECHANICAL CHARACTERISTICS**

CONNECTORS : SMA female per MIL C 39012  
 LIFE : 2.000.000 cycles  
 SWITCHING TIME (nominal voltage;25°C) : < 10 ms  
 CONSTRUCTION : splashproof  
 WEIGHT : < 100 g

**ENVIRONMENTAL CHARACTERISTICS**

OPERATING TEMPERATURE RANGE (°C) : -40 , +85  
 STORAGE TEMPERATURE RANGE (°C) : -55 , +85

(\* : average power at 25°C)

This information is given as an indication. In the continual goal to improve our products, we reserve the right to make any modifications judged necessary

**DRAWING**

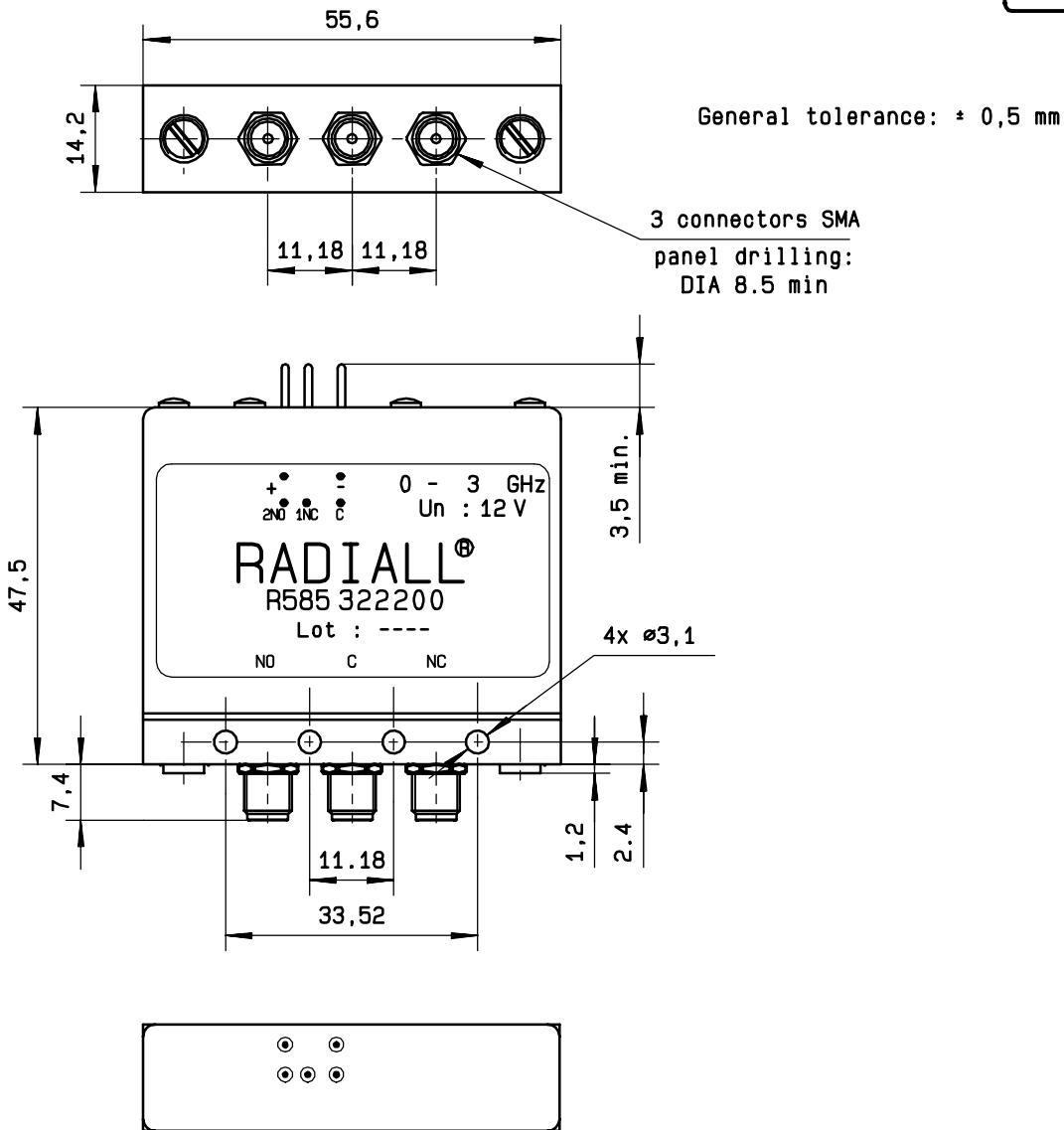

**SCHEMATIC DIAGRAM**

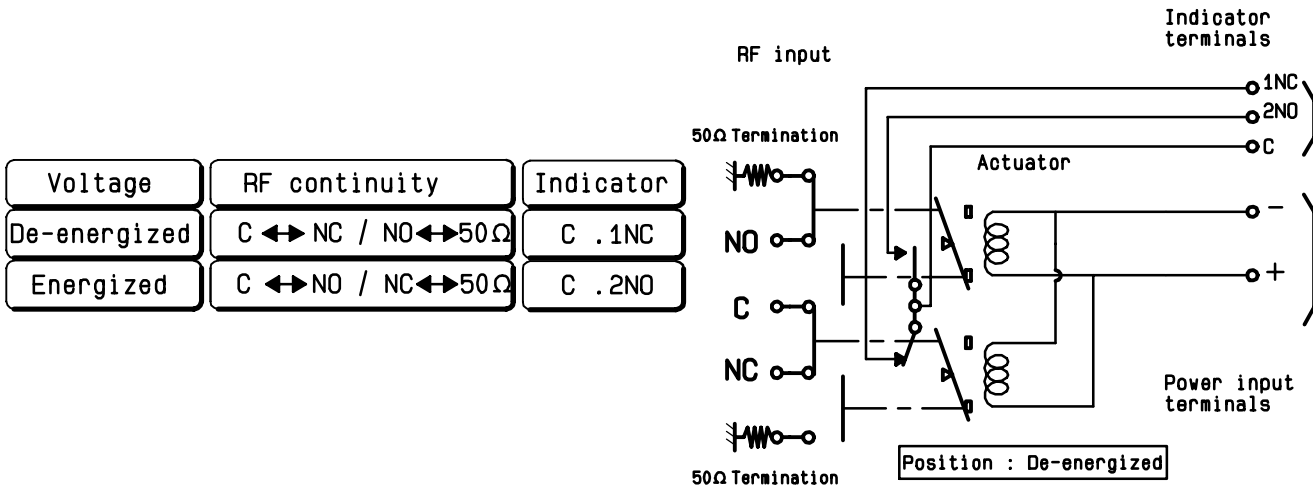

4113-9212 This information is given as an indication. In the continual goal to improve our products, we reserve the right to make any modifications judged necessary